

Mi TOWER+



ASSEMBLY GUIDE

Section	Page No
Contents	1
Introduction	2
Know Your MiTOWER+	3
Know Your MiTOWER+'s Components	4
Know Your Kit List and Specifications	5
Know Your Storage and Transport Pack	6
Safety Do's & Don'ts - ALWAYS	7
Safety Do's & Don'ts - NEVER	8
Before You Start	9
Getting Started	10
MiTOWER+ 2m - Assembly	11-12
MiTOWER+ 3m - Assembly	13-14
MiTOWER+ 4m - Assembly	15-16
MiTOWER+ 5m - Assembly	17-18
MiTOWER+ 6m - Assembly	19-20
10 Point Pre-Use Safety Checklist	21
Registrations	22

MiTOWER+ is a safe, versatile and high quality tower. It can be built by ONE PERSON and provides a work platform for up to TWO PEOPLE. It is designed in accordance with the latest testing and quality standards.

Our priority is to help ensure the safe operation of our products, so please pay particular attention to the safety tips on pages 7 and 8.

We want you to enjoy the safe and responsible use of **MiTOWER+** with the minimum of fuss and this guide is designed to get you up and running as quickly and as safely as possible. We recommend that you read this guide prior to assembling and using your **MiTOWER+**.

Scan this QR code to view the video of **MiTOWER+** in operation.



www.popupproducts.co.uk/videos/mitower+

Visit PASMA and HSE for further reference.



Parts Listing			
1	4 Rung Frame	4	Adjustable Leg and Castor
2	Toe Board Set	5	Guardrail Brace Panel
3	Easy-lock Stabiliser	6	Hatch Platform

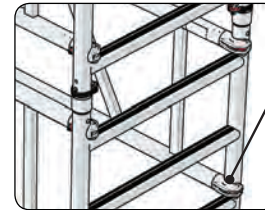

1. Guardrail Brace Panel

Hooks are fitted to the guardrail brace panels and each has an automatic locking jaw which is released by simply moving the jaw's trigger. The hook must only be attached to the frame with the opening facing outward. **Attachment with the jaw's opening facing inward will not fully protect the user if lent upon and may cause serious injury or death.** Always ensure that each hook is positively locked in position before using your MiTOWER+.

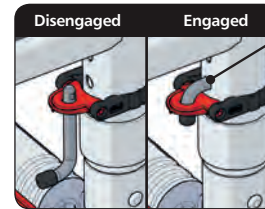

2. Easy-clip Frame Clips

The easy-clip frame clip's pin locates into a retaining hole in the frames to lock tower sections together when placed one on top of the other. The pin is locked in place by a red tab to ensure that it remains in place. From the disengaged position, pivot the pin / tab to bring the pin horizontal. Insert the pin fully through the retaining hole with its tail pointing down. Next flip the tab vertically to lock the pin in place. Removal is simply a reversal of the fitting sequence.

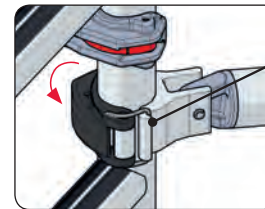

3. Easy-lock Stabiliser

The easy-lock clamps are used to secure the stabilisers to MiTOWER+'s vertical tubing. With the clamp jaw open, offer it to the tube. Bring the jaw around the tube and set the buckle on to the hook, then close the clamp arm to lock the stabiliser in position. A similar clamp is fitted to the stabiliser extension leg.

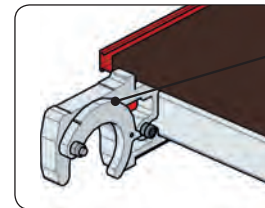

4. Wind-lock Catch

The wind-lock catch is a drop down jaw fitted to the side of the hatch platform's mounting hook and prevents the platform from lifting in windy conditions. It is attached to the horizontal tube of the frame. To disengage, simply lift and hold the jaw as you raise the platform clear.

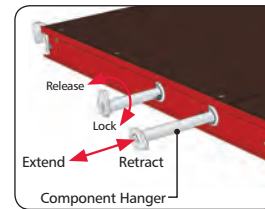

5. Platform with built in Easy-hang Hangers

To enable one man to erect MiTOWER+, each hatch platform is fitted with four easy-hang hangers which are stowed (two either side) within the platform's frame. The easy-hang hangers can be extended when needed and retracted when not. To extend and lock an easy-hang hanger, take a hold of the hanger stop end and pull from the frame. Once the stop rivet is clear of the slot, turn the hanger 45 degrees anticlockwise then gently slide back in until it stops. To retract the easy-hang hanger, simply reverse the procedure.

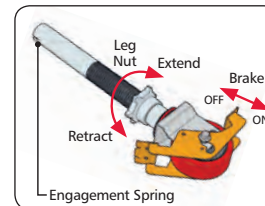

6. Adjustable Leg and Castor

The adjustable leg and castor allows for accurate positioning of your MiTOWER+ in relation to your workplace. The leg can be extended or retracted to allow for levelling and the brake must be applied to prevent movement.

COMPONENT MATRIX AND WEIGHTS

Platform Heights

Description	Weight (Unit) kg	2m qty	3m qty	4m qty	5m qty	6m qty
4 Rung Frame	3.55	6	8	10	12	14
Easy-lock Stabiliser	4.35	4	4	4	4	4
Hatch Platform	12.20	1	2	2	3	3
Guardrail Brace Panel	4.15	4	6	7	9	10
220mm Adjustable Leg	0.85	4	4	4	4	4
Locking Castor	2.45	4	4	4	4	4
Toe Board Set	6.50	1	1	1	1	1
MiTOWER+ Weight (kg)		87.20	114.80	126.05	153.65	164.90
Platform Safe Working Load (kg)		275	275	275	275	275

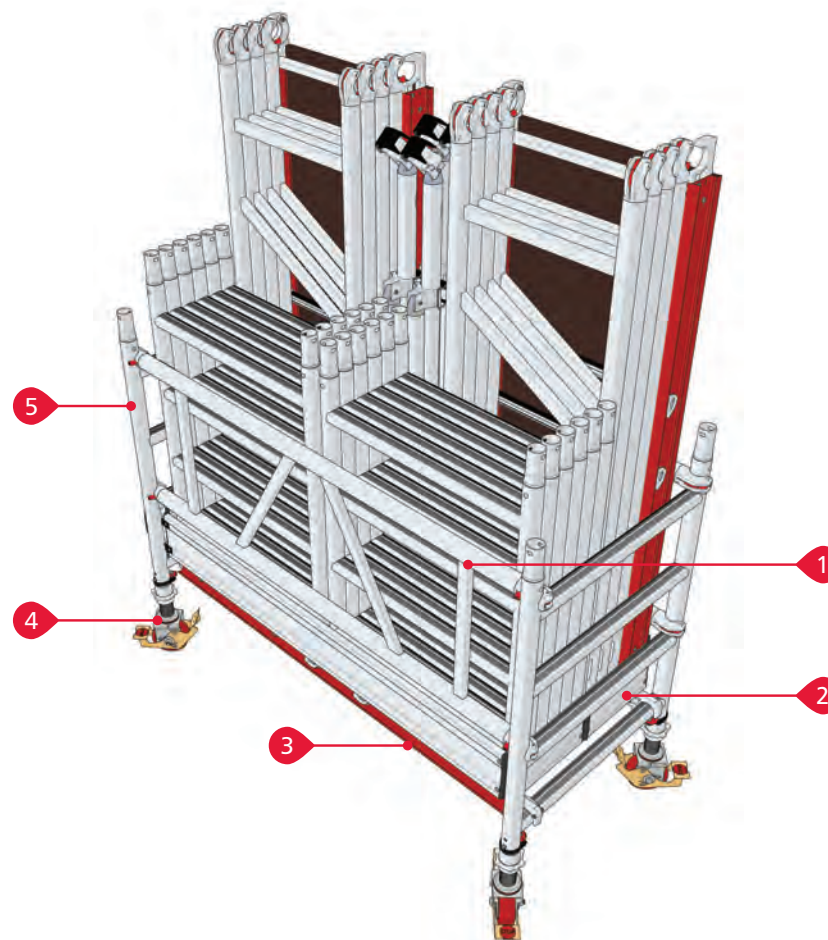
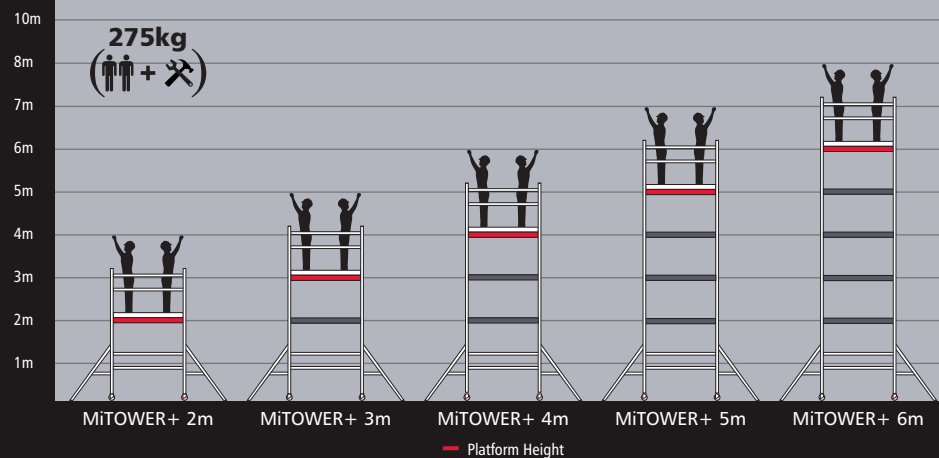

Transport & Storage

For ease of storage and of transportation, MiTOWER+ has been designed so that all components can be safely stored within the tower's base assembly. See illustration.

Product shown is MiTOWER+ 6m

Trolley Components

1	Guardrail Brace Panel x 2
2	Toe Board Set
3	Hatch Platform
4	Adjustable Leg & Castor x 4
5	4 Rung Frame x 2

Safety Do's & Don'ts - ALWAYS

ALWAYS	read and understand this guide before you begin assembly	✓
ALWAYS	ensure that all safety requirements are met and that MiTOWER+ is the correct access solution for the task you wish to perform	✓
ALWAYS	ensure that MiTOWER+ is assembled and dismantled by a qualified, competent person	✓
ALWAYS	cordon off the work area creating a zone with a radius that is 1m greater than the total height of MiTOWER+	✓
ALWAYS	wear the correct Personal Protective Equipment for the task being performed. Gloves, steel toecap boots, a hard hat and suitable clothing must be worn by all persons	✓
ALWAYS	tie back long hair and remove items of loose jewellery	✓
ALWAYS	perform a full risk assessment prior to assembling or using MiTOWER+ and abide by your findings	✓
ALWAYS	prevent access to unauthorised persons if you have no other option but to leave MiTOWER+ unattended and if this is not possible then MiTOWER+ must be dismantled	✓
ALWAYS	carry tools and materials safely retained in a tool belt that allows freedom of movement	✓
ALWAYS	ensure you properly assess the risk / method if tools or materials are hoisted to the platform via a rope	✓
ALWAYS	access platforms from within MiTOWER+ and via the 4 rung frames positioned at the platform's trap door end. Keep your feet in the middle of the rungs and grip the upper rungs with your hands	✓
ALWAYS	erect MiTOWER+ on smooth level ground that is capable of supporting its own weight, the user and any tools or materials without subsidence	✓

Safety Do's & Don'ts - NEVER

NEVER	use MiTOWER+ if you don't understand something in this guide; please contact the supplier for advice	✗
NEVER	assemble, use, move or dismantle MiTOWER+ if you are tired or unwell or if you are under the influence of alcohol or drugs	✗
NEVER	use MiTOWER+ in adverse weather conditions which may endanger the user	✗
NEVER	use in wind conditions of Beaufort Force 5 and above. Please be aware of the tunnel effect caused by buildings close to each other	✗
NEVER	assemble or use MiTOWER+ near overhead hazards such as power lines that are within reach of MiTOWER+ or the user	✗
NEVER	ascend or descend your MiTOWER+ if both hands are not free	✗
NEVER	add banners, notice boards etc to MiTOWER+	✗
NEVER	use MiTOWER+ if contaminated by paint, chemicals etc	✗
NEVER	overload the platforms (see component matrix page 5)	✗
NEVER	suspend MiTOWER+ from another structure	✗
NEVER	lean from MiTOWER+ and never apply undue side force	✗
NEVER	stand on the guardrails, toe boards, boxes (or similar) to gain extra height. If the working height is insufficient either construct MiTOWER+ to the required height or use an alternative method	✗
NEVER	use damaged components in your MiTOWER+ assembly	✗

Preparation

The floor area must be clear of any obstructions including materials and debris. Check that you have all the components necessary to construct the tower height you require. Check also each component for condition and correct function. If any part is missing or damaged/not working correctly it must be replaced before assembling the tower.

3T (THROUGH THE TRAPDOOR) SYSTEM

The 3T method of construction has been developed to reduce the risk of an erector falling from a tower during construction. The erector must sit on the platform with legs through the hatch and feet on the frame rungs when attaching guardrail brace panels above the platform. This ensures the erector is always protected by a set of guardrail brace panels.

Tying In

You should consider tying in the tower to add to stability, but this may only be carried out by a suitably trained person.

Ballast

Where shown in the component list, ballast must be used to stabilise against overturning. Only use solid materials as ballast (i.e. no loose materials) and position to avoid overloading individual components. Ballast should be supported by the base of your MiTOWER+ and securely fastened to prevent removal.

Assembly Guide

These instructions must always be made available to the user. If replacement copies are required, please contact your supplier.

Damaged Components

Regularly inspect all components for damage. Damaged components must be quarantined so that they cannot be used. Where safe to do so, the component can be repaired but only by a qualified repairer. If in doubt contact your supplier for advice.

Dismantling Your MiTOWER+

MiTOWER+ is easily dismantled by simply reversing the erection procedure. Make sure that the component hangers are evenly loaded to ensure your MiTOWER remains balanced. You must, however, be protected by guardrail brace panels when standing on any platform and ensure that you use the 3T method when removing guardrail brace panels.

Getting Started

MiTOWER+ requires only one person to assemble and dismantle it. Your MiTOWER+ is supplied with uniform 1m high 4 rung frames which can be used at any stage of the assembly. During erection, the frames may be connected together to create 2m high frames which makes assembly both quicker and easier.

Easy-lock Stabilisers Positioning

Easy-lock Stabilisers are supplied and must be used for all MiTOWER+ heights. For maximum effect arrange the Easy-lock Stabilisers by positioning at an angle of 45 degrees to give a footprint as close to square as possible, as shown in fig.1. If the tower is to be positioned against a wall, the Easy-lock Stabiliser footprint can be altered as shown in fig.2 but only where the height of the wall is a minimum of two thirds the height of the top working platform. Ensure that all four Easy-lock Stabilisers' feet are in contact with the ground and that the ground can support the weight of the tower and stabilisers.



Moving Your MiTOWER+

When your MiTOWER+ needs to be moved a small distance to enable you to continue your task, this can be achieved provided the easy-lock stabilisers can remain in pattern and all tools, materials and personnel are removed from the tower. You will need to raise the easy-lock stabilisers so that they are no more than 25mm above the floor and properly locked. However, if the easy-lock stabilisers have to be repositioned and this reduces the footprint, your MiTOWER+ must be reduced in height to 2m. You must only move MiTOWER+ by manual effort at a slow pace and only after fully assessing the risk. Once moved, always check MiTOWER+ before using. If MiTOWER+ is to be moved to a new location, a new level or over rough terrain, it must be fully dismantled and rebuilt at the new location.



Step 1 from trolley. For ease of storage and transportation your MiTOWER+ is designed so that all the components can be safely stored within the tower's base. Start by removing the free-standing components from within the trolley and stack safely nearby for use. Remove one of the guardrail brace panels and the hatch platform and store these with the other components. Level the base as described in **Step 2** and move to **Step 3**.

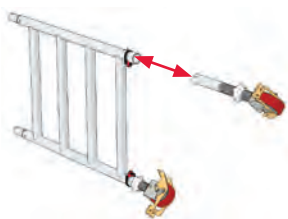

Step 1 from components. Fully insert the adjustable legs with castors into two frames, turning the leg's height adjustment collar to bring each leg 25mm from the lowest position.



Step 2. Attach a guardrail brace panel to the vertical tube of one frame with the upper hook positioned above the fourth rung and with all hooks facing outward. Make sure the hooks are correctly locked on to the frame tube. Now attach the second frame to the guardrail brace panel to create the base frame assembly. Lock all four castors and using a spirit level as a guide, adjust each leg to bring the base square and level.



Step 3. Construct two sets of conjoined frames, these will give you two 2m sections and will speed up the erection process. Release the easy-clip frame clips on one four rung frame and fit it on to a second four rung frame. Apply the easy-clip frame clips and ensure they are correctly locked. Repeat this with the second set. Fit one set of conjoined frames to a base frame and apply the easy-clip frame clips. Repeat this with the second set.



Step 4. Next, attach one guardrail brace panel with its lower jaw positioned above the sixth frame rung. It must be fitted on the opposite side to the first guardrail brace panel to ensure stability. Ensure all hooks are facing outward and correctly locked on to the frame tube.



Step 5. Stand inside the tower and fit a platform on to the eighth rung, making sure that the wind-lock catches engage.



Step 6. Fit an easy-lock stabiliser to each corner of the tower. Position the lower horizontal easy-lock clamp just above the frame's second rung, then secure the top easy-lock clamp just above the frame's fifth rung. Adjust the easy-lock stabilisers so that you create as square a footprint as possible. Adjust each stabiliser's length so that they are in contact with the ground. Make sure all easy-lock clamps are correctly secured.



Step 7. Extend and lock the four easy-hang hangers located on either side of the platform. Place two guardrail brace panels on to one set of hangers, and the toe board set on to the opposite side.



Step 8. Enter the tower framework and climb the frame rungs until you are half way through the platform's trap door. Now manoeuvre yourself so that you are sitting on the platform, with your legs through the trap door and your feet on the frame rungs. From this position, you should take each of the guardrail brace panels, one at a time, and attach so that the upper jaws are positioned above the uppermost rung.

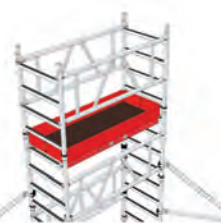

Step 9. With both guardrail brace panels in position, you may access the platform. Unfold the toe board set and position so that it sits on the outer edge of the platform. Finally, retract all easy-hang hangers and the tower is now complete and ready to use.



Step 1. Replicate Steps 1 and 2 from 2m build.
Fit a platform on to the fourth rung, making sure that the wind-lock catches engage. Next fit a single 1m frame to a base frame and apply the easy-clip frame clips, then fit a second 1m frame to the other base frame and apply the easy-clip frame clips.



Step 2. Next, attach a pair of guardrail brace panels opposite each other with their upper jaws positioned above the uppermost frame rung. Ensure all hooks are facing outward and correctly locked on to the frame tube.



Step 3. Fit an easy-lock stabiliser to each corner of the tower. Position the lower horizontal easy-lock clamp just above the frame's second rung, and then secure the top easy-lock clamp just above the frame's fifth rung. Adjust the easy-lock stabilisers so that you create as square a footprint as possible. Adjust each stabiliser's length so that they are in contact with the ground. Make sure all easy-lock clamps are correctly secured.



Step 4. Construct two sets of conjoined frames, giving you two 2m sections. Take a four rung frame, release the easy-clip frame clips and fit it on to a second four rung frame. Apply the easy-clip frame clips ensuring they are correctly locked and then repeat this process with the second set. Place the conjoined frames one at each end of the tower ready to be fitted. Extend and lock the four easy-hang hangers located on either side of the first platform. Place a guardrail brace panel on to an easy-hang hanger on one side of the platform and a second platform on the other side.



Step 5. Access the first platform. Fit one set of conjoined frames to each end of the tower and apply the easy-clip frame clips. Next, attach the guardrail brace panel with its lower jaw positioned above the ninth frame rung. Ensure all hooks are facing outward and correctly locked on to the frame tube. Now carefully fit the second platform on to the twelfth rung, making sure that the wind-lock catches engage. Extend and lock the four easy-hang hangers located on either side of the platform.



Step 6. Descend the tower and from the ground place two guardrail brace panels onto the hangers on one side of the higher platform and a toe board set on the other side.



Step 7. Access the tower until you are half way through the second platform's trap door. Now manoeuvre yourself so that you are sitting on the platform, with your legs through the trap door and your feet on the frame rungs. From this position, you should take each of the guardrail brace panels, one at a time, and attach so that the upper jaws are positioned above the uppermost rung.

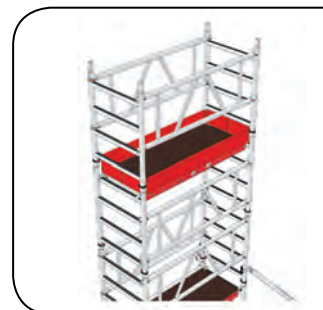

Step 8. With both guardrail brace panels in position, you may access the platform. Unfold the toe board set and position so that it sits on the outer edge of the platform. Finally, retract all easy-hang hangers and the tower is now complete and ready to use.



Step 1. Replicate Steps 1 to 6 from 2m build.

Extend and lock the four easy-lock hangers located on either side of the platform. From the ground place three guardrail brace panels onto the easy-lock hangers on one side of the platform and two sets of conjoined four rung frames on the other side.



Step 2. Access the tower until you are half way through the platform's trap door. Now manoeuvre yourself so that you are sitting on the platform, with your legs through the trap door and your feet on the frame rungs. From this position, you should take each of the guardrail brace panels, one at a time, and attach so that the upper jaws are positioned above the uppermost rung.



Step 3. Access the first platform. Fit one set of conjoined frames to each end of the tower and apply the easy-clip frame clips. Next, attach the guardrail brace panel with its lower jaw positioned above the thirteenth frame rung. Ensure all hooks are facing outward and correctly locked on to the frame tube.



Step 4. Descend the tower and from the ground place two guardrail brace panels onto the easy-hang hangers on one side of the platform and a toe board set and a platform on the other side.



Step 5. Access the first platform and carefully fit the second platform on to the sixteenth rung, making sure that the wind-lock catches engage. Next extend and lock the four easy-hang hangers located on either side of the second platform. Move the two guardrail brace panels from the easy-hang hangers on the first platform on to the the easy-hang hangers of the second platform and then repeat the process with the toeboard set on the other side of the platform.



Step 6. Access the tower until you are half way through the second platform's trap door. Now manoeuvre yourself so that you are sitting on the platform, with your legs through the trap door and your feet on the frame rungs. From this position, you should take each of the guardrail brace panels, one at a time, and attach so that the upper jaws are positioned above the uppermost rung.



Step 7. With both guardrail brace panels in position, you may access the platform. Unfold the toe board set and position so that it sits on the outer edge of the platform. Finally, retract all easy-hang hangers and the tower is now complete and ready to use.



Step 1. Replicate Steps 1 to 5 from 3m build.

Extend and lock the four easy-hang hangers located on either side of the platform. From the ground place three guardrail brace panels onto the easy-hang hangers on one side of the platform and two sets of conjoined four rung frames on the other side.



Step 2. Access the tower until you are half way through the platform's trap door. Now manoeuvre yourself so that you are sitting on the platform, with your legs through the trap door and your feet on the frame rungs. From this position, you should take each of the guardrail brace panels, one at a time, and attach so that the upper jaws are positioned above the uppermost rung.



Step 3. Access the second platform and fit a set of conjoined frames to each end of the tower and apply the easy-clip frame clips. Next, attach the guardrail brace panel with its lower jaw positioned above the seventeenth frame rung. Ensure all hooks are facing outward and correctly locked on to the frame tube.



Step 4. Descend the tower and from the ground place two guardrail brace panels onto the easy-hang hangers on one side of the second platform and a toe board set and a platform on the other side.



Step 5. Access the second platform and carefully fit the third platform on to the twentieth rung, making sure that the wind-lock catches engage. Next extend and lock the four easy-hang hangers located on either side of the second platform. Move the two guardrail brace panels from the easy-hang hangers on the second platform on to the the easy-hang hangers of the third platform and then repeat the process with the toeboard set on the other side of the platform.



Step 6. Access the tower until you are half way through the third platform's trap door. Now manoeuvre yourself so that you are sitting on the platform, with your legs through the trap door and your feet on the frame rungs. From this position, you should take each of the guardrail brace panels, one at a time, and attach so that the upper jaws are positioned above the uppermost rung.



Step 7. With both guardrail brace panels in position, you may access the platform. Unfold the toe board set and position so that they sit on to the outer edge of the platform. Finally, retract all easy-hang hangers and the tower is now complete and ready to use.

**Step 1. Replicate Steps 1 to 3 from 4m build.**

Extend and lock the four easy-hang hangers located on either side of the platform. From the ground place two guardrail brace panels onto the easy-hang hangers on one side of the platform and a platform on the other side.



Step 2. Access the first platform and carefully fit the second platform on to the sixteenth rung, making sure that the wind-lock catches engage. Next extend and lock the four easy-hang hangers located on either side of the second platform. Move the two guardrail brace panels from the easy-hang hangers on the first platform on to the the easy-hang hangers of the second platform.



Step 3. Access the tower until you are half way through the platform's trap door. Now manoeuvre yourself so that you are sitting on the platform, with your legs through the trap door and your feet on the frame rungs. From this position, you should take each of the guardrail brace panels, one at a time, and attach so that the upper jaws are positioned above the uppermost rung.



Step 4. Descend the tower and from the ground place three guardrail brace panels onto the easy-hang hangers on one side of the first platform and two sets of conjoined four rung frames on the other side.



Step 5. Access the first platform and move the three guardrail brace panels from the easy-hang hangers on the first platform on to the the easy-hang hangers of the second platform. Repeat the process with the two sets of conjoined four rung frames. Access the second platform and fit a set of conjoined frames to each end of the tower and apply the easy-clip frame clips. Next, attach the guardrail brace panel with its lower jaw positioned above the seventeenth frame rung. Ensure all hooks are facing outward and correctly locked on to the frame tube.

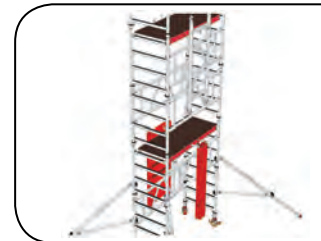

Step 6. Descend the tower and from the ground place a toeboard set on to the easy-hang hangers of the tower platform on the same side that the two guardrail brace panels are hanging. Then place a platform on the easy-hang hangers on the other side of the lower platform.

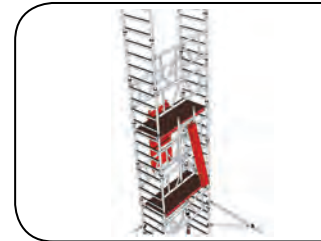

Step 7. Access the first platform and move the toeboard set from the easy-hang hangers on the first platform on to the easy-hang hangers of the second platform. Repeat the process with the platform on the other side.



Step 8. Access the second platform and carefully fit the third platform on to the twentieth rung, making sure that the wind-lock catches engage. Next, extend and lock the four easy-hang hangers located on either side of the platform. Move the toeboard set from the easy-hang hangers on the second platform onto the easy-hang hangers on the opposite side of the third platform. Then move the two guardrail brace panels up to the easy-hang hangers on the third platform.



Step 9. Access the tower until you are half way through the third platform's trap door. Now manoeuvre yourself so that you are sitting on the platform, with your legs through the trap door and your feet on the frame rungs. From this position, you should take each of the guardrail brace panels, one at a time, and attach so that the upper jaws are positioned above the uppermost rung.

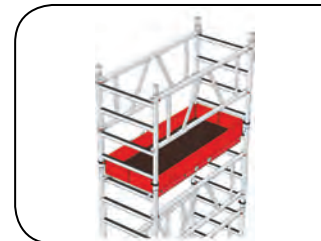

Step 10. With both guardrail brace panels in position, you may access the platform. Unfold the toe board set and position so that it sits on the outer edge of the platform. Finally, retract all easy-hang hangers and the tower is now complete and ready to use.

10 Point Pre-Use Checklist for Users

1	Before Use	completed tower must be checked by a competent person	✓
2	Components	check all components are free from damage	✓
3	Castors	ensure they are locked	✓
4	Environment	check your MiTOWER+ is level	✓
5	Easy-lock Stabilisers	check they are secure	✓
6	Guardrail Brace Panels	make sure all platforms are fully enclosed by guardrail brace panels	✓
7	Guardrail Brace Panel Hooks	check they are locked correctly	✓
8	Windlock Catches	make sure they are engaged	✓
9	Easy-clip Frame Clips	make sure they are engaged	✓
10	Toe Board Set	check it is correctly positioned on the platform	✓



PASMA
Member

EN 1004
Class 3



ISO9001 : 2008
Certificate No.FM 513133





popupproducts.co.uk

+44 (0)1244 833 933

info@popupproducts.co.uk